

LED MODULES FOR MAINS VOLTAGE

DRIVER-ON-BOARD
TECHNOLOGY



LED MODULES READYLINE C

Built-in LED modules with integrated driver for direct connection to mains voltage

With so-called Driver-on-Board technology (DoB), the control gear unit is directly integrated into the LED module, which permits direct connection to mains voltage (220–240 V, 50–60 Hz).

The built-in LED modules of the ReadyLine series are suitable for residential and furniture lighting, as a replacement for halogen, energy-saving compact fluorescent lamps.

Advantages at a glance

- Direct connection to mains voltage
- Glued protection cover to prevent electrical shock
- More flexible space-saving luminaire designs due to absence of driver

Technical notes

Mains voltage: 220–240 V, 50/60 Hz

Initially colour accuracy: 3SDCM

CRI: > 90 (2700–3000 K)

High power factor: > 0.9

Protection cover: PC, UV-glued

or rivetted (module with heat sink)

Long service life: up to 50,000 hours

For luminaires of protection class I

(you will find further information in our "Innovative Systems 2016" catalogue on page 229)

RFI suppressed

THD: < 20%

Aluminium PCB for optimum thermal management

Heat sink made of thermoconductive resin

or co-moulded heat sink made of thermoconductive resin and aluminium

Typical applications

- Replacement for compact fluorescent lamps (ideal for wall-mounted and ceiling-mounted luminaires)
- Integration in luminaires
- Residential lighting
- Architectural lighting
- Retail lighting
- Furniture lighting

ReadyLine C 07 – 16.6 W

Technical notes

Power factor: > 0.97

Surge protection: ≥ 1 kV

Dimensions: Ø 74 mm;

Ø 120 mm with co-moulded heat sink

Screw terminals for LED module with heat sink:
2.5 mm²

Welded leads for LED module without heat sink:
double FEP/FEP-insulation, length: 250 mm,
central or lateral lead exit

Fixing holes for screws M3 or self-tapping screws 2.9

Lumen maintenance: L70/B50, 50,000 hrs. at $t_c = 75\text{ °C}$

Max. operating temperature at t_c point: 90 °C

Versions for the US market on request

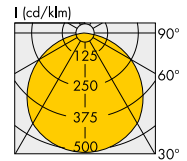
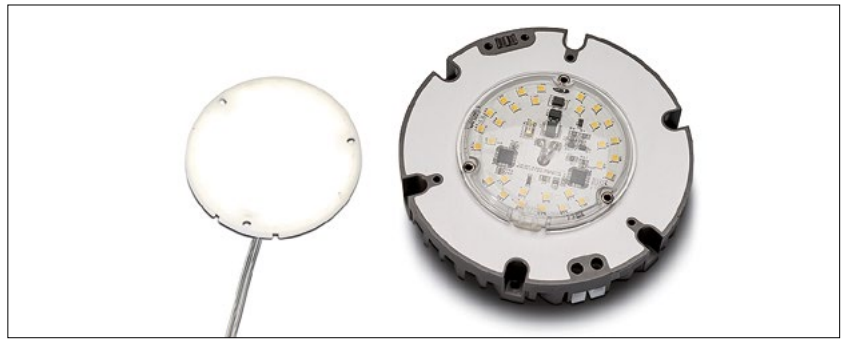

With heat sink, protection cover and 2-poles screw terminals

With central lead exit

With lateral lead exit

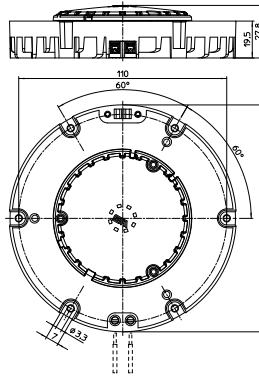
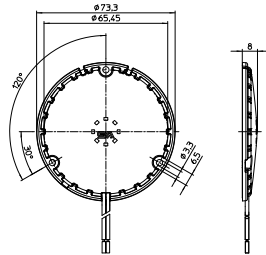
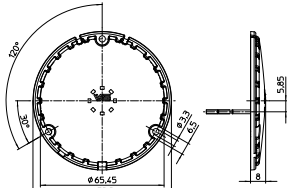

Max. output W	Type	Ref. No.		Voltage AC 50/60 Hz V	Number of LEDs pcs.	Colour	Correlated colour temperature K	Cover	Typ. luminous flux (lm)	CRI R_a	Lead exit	Energy efficiency
		with heat sink	without heat sink									
16.6	LR30V	565171	565167	220–240	30	warm white	2600...2900	clear	1350	> 90	central	A+
	LR30V	on request	565168								lateral	A+
	LR30V	565172	565169	220–240	30	warm white	2600...2900	diffuse	1210	> 90	central	A
	LR30V	on request	565170								lateral	A
	LR30V	565177	565173	220–240	30	warm white	2900...3200	clear	1480	> 90	central	A+
	LR30V	on request	565174								lateral	A+
	LR30V	565178	565175	220–240	30	warm white	2900...3200	diffuse	1330	> 90	central	A+
	LR30V	on request	565176								lateral	A+
	LR30V	565183	565179	220–240	30	neutral white	3700...4200	clear	1700	> 80	central	A+
	LR30V	on request	565180								lateral	A+
	LR30V	565184	565181	220–240	30	neutral white	3700...4200	diffuse	1530	> 80	central	A+
	LR30V	on request	565182								lateral	A+

Application	Diameter mm	Ref. No.	Description	Tape thickness (mm)	Thermal conductivity W/mK	Breakdown voltage* (kV)	Drawing Page 6
—	—	552039	Cord grip with 2 screws for LED modules with heat sink	—	—	—	—
Class I	68	553422**	Thermally conductive transfer tape, non-adhesive	0.25	2	3	—
Class II	76	565846***	Thermally conductive transfer tape, adhesive on both sides	0.19	0.9	10.3	A

* Average value (not for specification purpose) | ** Optional for class I luminaires | *** Necessary for class II luminaires

The values contained in this data sheet can change due to technical innovations. Any such changes will be made without separate notification.

ReadyLine C 05 – 8.5 W

Technical notes

Power factor: > 0.97
 Surge protection: ≥ 1 kV
 Dimensions: Ø 46 mm
 Welded leads: double FEP/FEP-insulation,
 length: 250 mm, central or lateral lead exit
 MOV – metal-oxide varistor,
 enclosed unassembled
 Fixing holes for screws M2
 Lumen maintenance: L70/B50, 50,000 hrs. at $t_c = 75\text{ °C}$
 Max. operating temperature at t_c point: 90 °C
 Versions for the US market on request

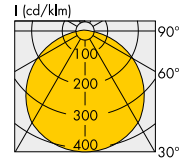

8.5 W – With lateral lead exit

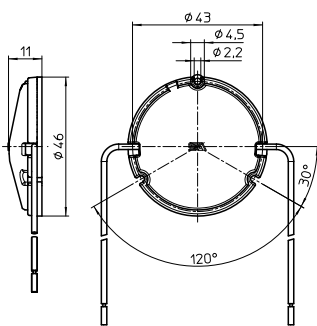

8.5 W – With central lead exit

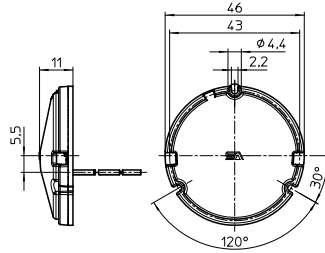

MOV

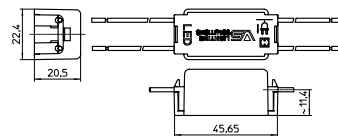

Max. output W	Type	Ref. No.	Voltage AC 50/60 Hz V	Number of LEDs pcs.	Colour	Correlated colour temperature K	Cover	Typ. luminous flux lm	CRI R_a	Lead exit	Energy efficiency			
8.5	LR15W	565213	220–240	15	warm white	2600...2900	clear	680	> 90	central	A+			
	LR15W	565214								lateral	A+			
	LR15W	565215								diffuse	620	> 90	central	A
	LR15W	565216								diffuse	620	> 90	lateral	A
	LR15W	565217	220–240	15	warm white	2900...3200	clear	740	> 90	central	A+			
	LR15W	565218								lateral	A+			
	LR15W	565219								diffuse	660	> 90	central	A+
	LR15W	565220								diffuse	660	> 90	lateral	A+
	LR15W	565221	220–240	15	neutral white	3700...4200	clear	850	> 80	central	A+			
	LR15W	565222								lateral	A+			
	LR15W	565223								diffuse	770	> 80	central	A+
	LR15W	565224								diffuse	770	> 80	lateral	A+

Application	Diameter mm	Ref. No.	Description	Tape thickness (mm)	Thermal conductivity W/mK	Breakdown voltage* (kV)	Drawing Page 6
Class I	45	554421**	Thermally conductive transfer tape, non-adhesive	0.25	2	3	–
Class II	52	565845***	Thermally conductive transfer tape, adhesive on both sides	0.19	0.9	10.3	A

* Average value (not for specification purpose) | ** Optional for class I luminaires | *** Necessary for class II luminaires

The values contained in this data sheet can change due to technical innovations. Any such changes will be made without separate notification.

ReadyLine C 03 – 4.5 W

Technical notes

Power factor: > 0.97
 Surge protection: ≥ 1 kV
 Dimensions: Ø 33 mm
 Welded leads: double FEP/FEP-insulation,
 length: 250 mm, lateral lead exit
 MOV – metal-oxide varistor,
 enclosed unassembled
 Fixing holes for screws M2
 Lumen maintenance: L70/B50, 50,000 hrs. at $t_c = 75\text{ °C}$
 Max. operating temperature at t_c point: 90 °C

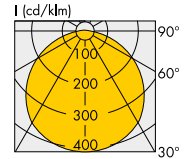

4,5 W – With lateral lead exit

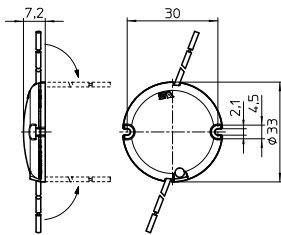

MOV

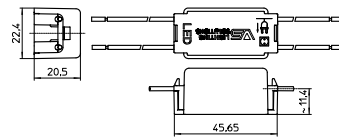

Max. output W	Type	Ref. No.	Voltage AC 50/60 Hz V	Number of LEDs pcs.	Colour	Correlated colour temperature K	Cover	Typ. luminous flux lm	CRI R _a	Lead exit	Energy efficiency
4.5	LR8W	563933	220–240	8	warm white	2600...2900	clear	420	> 80	lateral	A++
	LR8W	563934					diffuse	370	> 80	lateral	A++
	LR8W	563935	220–240	8	warm white	2900...3200	clear	440	> 80	lateral	A++
	LR8W	563936					diffuse	400	> 80	lateral	A++
	LR8W	563937	220–240	8	neutral white	3700...4200	clear	460	> 80	lateral	A++
	LR8W	563938					diffuse	410	> 80	lateral	A++

Application	Diameter mm	Ref. No.	Description	Tape thickness (mm)	Thermal conductivity W/mK	Breakdown voltage* (kV)	Drawing Page 6
Class I	33.2	559966**	Thermally conductive transfer tape, non-adhesive	0.25	2	3	–
Class II	39	565844***	Thermally conductive transfer tape, adhesive on both sides	0.19	0.9	10.3	A

* Average value (not for specification purpose) | ** Optional for class I luminaires | *** Necessary for class II luminaires

The values contained in this data sheet can change due to technical innovations. Any such changes will be made without separate notification.

ReadyLine C

Assembly and Safety Information

The LED modules are designed for direct mains operation (230 V AC). Installation must be carried out under observation country specific relevant safety regulations and standards.

- The LED module is a built-in lighting module to assemble into luminaires. 
- Suitable for luminaires of protection class I, grounding is mandatory to comply with safety standards.
- In case of applications in luminaires of protection class II the safety regulations acc. to luminaire safety standards must be observed.
- Operation of the LED module is not allowed when it is not built-in into a luminaire. Depending on application, luminaire application specific safety standards have to be observed (e.g. EN 60598-1 for Europe). Depending on the use of the luminaire in different countries (export), the country specific safety standards have to be regarded (e.g. EN 60598-1 for Europe).
 - Regard to sufficient isolation acc. country specific standards.
 - Live parts must not be touched. Luminaire must be closed acc. country specific standards.
- Clearance and creepage distances of the module are designed for class I luminaires (basic insulation). For built-in of the module the required standards have to be observed (e.g. EN 60598-1).
- Do not exceed values given in this specification.
- Do not exceed max t_c temperature of 90 °C.
- The module must be fixed onto a thermally conductive surface. Heat sink must cover the entire backside surface of the module.
- For the operation of VS recommends to mount the module directly onto the metal heat sink or luminaire housing is mandatory to comply with immunity standards (e.g. EN 61547).
- When installing/screwing the module into a luminaire, please ensure that cables are not squeezed between luminaire/heat-sink and LED module.
- Please ensure standard ESD (electrostatic discharge) protection measures are employed when handling and installing LED modules. Electrostatic discharge can damage LEDs.
- Parallel connection is mandatory for safe electrical operation. Serial connection of LED modules is not allowed.
- Due to the used electronic parts on the module not all available phase-cutting dimmers are compatible. Dimmable with phase-cutting leading- and trailing-edge dimmer. Minimum dimmer load has to be observed. The compatibility of the dimmer and the modules has to be confirmed prior to installation to avoid flickering.
- To ensure problem-free operation, the specified maximum temperature at the t_c point (see "Operating Life") must be observed (measured in accordance with EN 60598-1). To satisfy this point, it is necessary to put measures in place to ensure any heat is dissipated from the LED module to the environment.



- In the event of outdoor applications or applications in damp locations, care must be taken to protect LED assembly modules against humidity, splashes and jets of water. Any corrosion damage resulting from humidity or contact with condensation will not be recognised as a defect or manufacturing fault. LED assembly modules are not specially protected against foreign bodies or dust. Depending on the type of application, further protection must be ensured to prevent dust and foreign bodies from entering. Relevant country and application specific standards have to be regarded.
- Installation by qualified electrician only
- Do not add or change wires while circuit is active
- Do not make modifications on module
- Do not use adhesives to attach that outgas organic vapour
- Do not use together with material containing sulfur
- Do not operate module with AC generators
- Do not operate modules by DC
- LED modules must not be subjected to any undue mechanical stress, e. g.: LED module
 - handle modules carefully
 - avoid shear and compressive forces onto the modules during handling and installation
 - avoid vibrations of more than 2 kHz, 40 G
- If module is used in rooms with fast moving parts as the light modulation might cause stroboscopic effects.
- This LED module might interfere with displays and cameras due to modulation.
- The photobiological safety of the LED modules is classified into risk groups in accordance with EN 62471: 2008 and IEC TR 62778: risk group 1

Applied Standards

- EN 62031
LED modules for general lighting – Safety specifications
- EN 62471 and IEC TR 62778
Photobiological safety of lamps and lamp systems
- EN 55015
Radio disturbance emissions
- EN 61000-3-2
Limits for harmonic emissions
- EN 61547
Immunity requirements

Product Guarantee

- 5 years
- The conditions for the Product Guarantee of the Vossloh-Schwabe Group shall apply as published on our homepage (www.vossloh-schwabe.com).
We will be happy to send you these conditions upon request.

The values contained in this data sheet can change due to technical innovations. Any such changes will be made without separate notification.

Thermal Tapes for ReadyLine C Modules

For ReadyLine C07

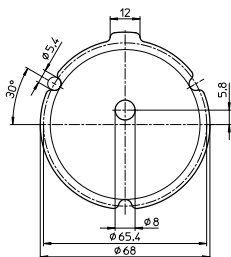

Ref. No.: 553422

For ReadyLine C05

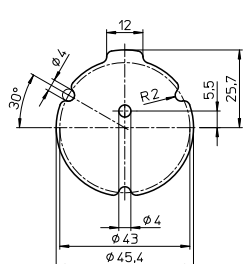

Ref. No.: 554421

For ReadyLine C03

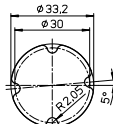

Ref. No.: 559966

Drawing A

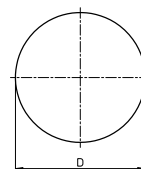

ReadyLine C – tested dimmers

LED modules ReadyLine C are dimmable with common phase-cut dimmers. The minimum dimming load has to be respected. The compatibility of the LED modules with the dimmer has to be confirmed prior to installation.

- Busch Jäger 2247U
- GET
- Gira 30200
- IKEA E0902 DIM
- IKEA EED10OPRS
- IKEA EED20PRS
- IKEA EED200BRS
- IKEA SED300FHS
- Jung 225 NV DE
- Kopp 8068
- Merten 572599
- MK 5004091-001
- Selectric SSL509
- Relco DimLED 34/65
- Relco DT/ACR
- Relco LT 1 UN
- Relco SNELLO/ACR (RL7180 – RL7190)
- Relco RONDO/CR (RL7181 – RL7191)
- Zano ZANOWH250

The values contained in this data sheet can change due to technical innovations. Any such changes will be made without separate notification.