

LEDSPOTS CC

ACTIVE PLUS – GEN. 2



NEW MODULAR LED SPOTS AND ENGINES FOR MULTIPLE OPTICS CONFIGURATIONS

One of the main characteristics of this LED spots and engines is their flexibility. The modularity of these LED engines allows you to combine different lenses and reflectors in order to get the result you expect.

Moreover, with its easy to fit technology you connect lenses or reflectors in a blink of an eye – just click it in.

Typical applications for LEDSpots

Integration in luminaires

- Residential lighting
- Retail lighting
- Hospitality lighting
- Museum lighting



Active Plus – Gen. 2

- **MODULAR SYSTEM: ENGINE + OPTICS**
- **NARROW COLOUR TOLERANCES: 2 STEP MACADAM (S124)**
- **COLOUR RENDERING INDEX: CRI 80 AND CRI 95**
- **LUMINOUS FLUX: UP TO 1750 LM**
- **MADE IN ITALY**



LED Engines for Active PLUS and Evolve 50

LEDSpot engine equipped with LED module, holder, thermal pad, heat sink and leads but without reflector or lenses

Technical notes

For reflectors PLUS and lens Evolve

Optics fixation: click-in

Heat sink material: aluminium

Lumen maintenance:

L90/B10 (S124) or L90/B20 (7.2/9.2);

50,000 hrs. at max. allowed operation current and

75 °C at t_p point

Temperature depends on installation situation and has to be checked by the luminaire manufacturer.

Colour accuracy initially: 2 SDCM (S124);

3 SDCM (7.2/9.2)

Leads: Cu tinned, stranded conductors 0.5 mm²,

length: 200 mm, stripped lead ends (with plug on request)

With integrated cord grip

Packaging unit: see page 11



LEDSpot Engine S124



LEDSpot Engine 7.2 & 9.2



LEDSpot Engine HALO

Maximum ratings

Exceeding the maximum ratings can lead to reduction of service life or destruction of the modules.

Type	Ambient temperature range (t_a)		Operation temp. at t_c point with max. current		Storage temperature range		Max. allowed repetitive peak current mA
	°C min.	°C max.	°C min.	°C max.	°C min.	°C max.	
S124	-20	+45	-25	+90	-40	+90	800
7.2/9.2	-20	+45	-25	+90	-40	+90	1000

Temperatures depend on installation situation and has to be checked by the luminaire manufacturer.

A – Engine S124

B – Engine S124

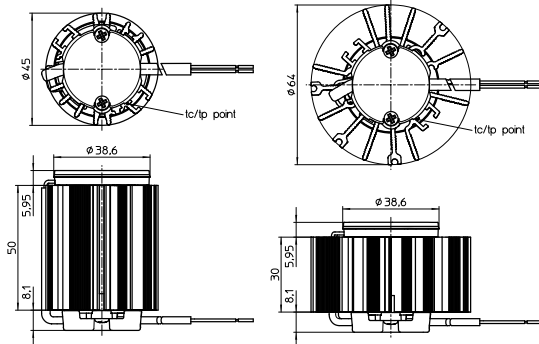

C – Engine 9.2

D – Engine 7.2

E – Engine Halo

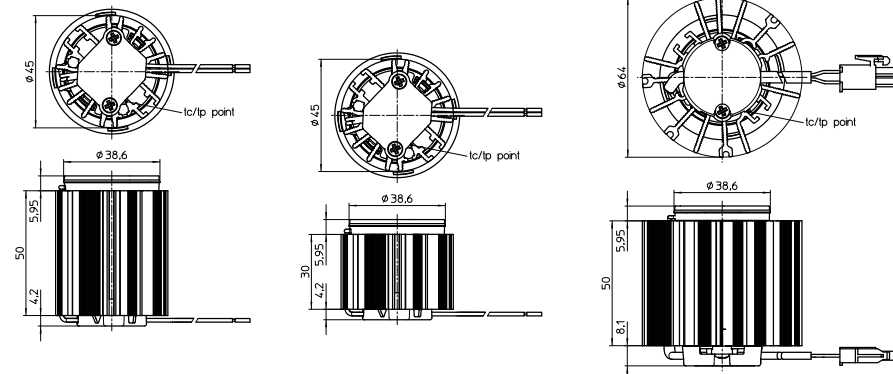

The values contained in this data sheet can change due to technical innovations. Any such changes will be made without separate notification.

LED Engines for Active PLUS and Evolve 50

Electrical characteristics

Type	50 mA		250 mA		300 mA		350 mA		500 mA	
	P _{el} (W)	V _f (V)	P _{el} (W)	V _f (V)	P _{el} (W)	V _f (V)	P _{el} (W)	V _f (V)	P _{el} (W)	V _f (V)
Engine S124	–	–	8.3	33.4	10.2	33.8	12.0	34.3	–	–
Engine 9.2	–	–	4.1	16.5	5.0	16.7	6.1	17.3	8.9	17.85
Engine 7.2	–	–	4.1	16.5	5.0	16.7	6.1	17.3	–	–
Engine Halo	1.6	31.4	–	–	–	–	12.9	37	–	–

Voltage and power tolerance: ± 10%

Optical characteristics

at t_p 70 °C

Type	Ref. No.	Colour	Correlated colour temperature K	Typ. luminous flux and efficiency at				CRI	Energy efficiency at max. current
				250 mA		300 mA			
				lm	lm/W	lm	lm/W	R _a	

LEDSpot Engine S124 up to 300 mA – Drawing A

Engine S124W@300mA	569135	warm white	2700	1195	144	1410	138	82	A++
Engine S124W@300mA	569136	warm white	3000	1035	125	1215	119	95	A++
Engine S124W@300mA	569137	neutral white	4000	1135	137	1330	130	95	A++

Production tolerance of luminous flux and efficiency: ± 10%

Type	Ref. No.	Colour	Correlated colour temperature K	Typ. luminous flux and efficiency at						CRI	Energy efficiency at max. current
				250 mA		300 mA		350 mA			
				lm	lm/W	lm	lm/W	lm	lm/W	R _a	

LEDSpot Engine S124 up to 350 mA – Drawing B

Engine S124W@350mA	569138	warm white	2700	1195	144	1410	138	1615	135	82	A++
Engine S124W@350mA	569139	warm white	3000	1035	125	1215	119	1395	116	95	A++
Engine S124W@350mA	569140	neutral white	4000	1135	137	1330	130	1520	127	95	A++

Production tolerance of luminous flux and efficiency: ± 10%

Type	Ref. No.	Colour	Correlated colour temperature K	Typ. luminous flux and efficiency at				CRI	Energy efficiency at max. current
				350 mA		500 mA			
				lm	lm/W	lm	lm/W	R _a	

LEDSpot Engine 9.2 – Drawing C

Engine 9.2 500mA	567038	warm white	2700	775	127	1070	120	80	A++
Engine 9.2 500mA	567040	warm white	3000	805	132	1120	126	80	A++
Engine 9.2 500mA	567041	neutral white	4000	835	137	1160	130	80	A++

LEDSpot Engine 7.2 – Drawing D

Engine 7.2 350mA	567032	warm white	2700	775	127	–	–	80	A++
Engine 7.2 350mA	567033	warm white	3000	805	132	–	–	80	A++
Engine 7.2 350mA	567034	neutral white	4000	835	137	–	–	80	A++

Production tolerance of luminous flux and efficiency: ± 10%

Type	Ref. No.		Colour	Correlated colour temperature K	Typ. luminous flux and colour temperature at				CRI	Energy efficiency at max. current
	without connector	with connector			50 mA		350 mA			
				lm	K	lm	K	R _a		

LEDSpot Engine Halo – Drawing E

Engine Halo 350mA	569772	569773	warm white	3000 → 2000	130	2000	1200	3000	90	A+
-------------------	---------------	---------------	------------	-------------	-----	------	------	------	----	----

Production tolerance of luminous flux and efficiency: ± 10%

The values contained in this data sheet can change due to technical innovations. Any such changes will be made without separate notification.

Reflectors PLUS for LED Engines

Technical notes

For click-in fixation on holders Easy

Diameter: 50 mm

Material: PC

Operating temperature: -25 to 90 °C

Storage temperature: -40 to 90 °C

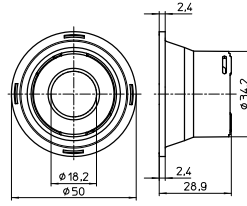

Ref. No.	For LED modules	Beam angle [°]	Cover	Optical efficiency (%)	Weight g
603685	S124, 9.2, 7.2	16	Clear	87	10
603687	S124, 9.2, 7.2	24	Clear	86	10
604919	S124, 9.2, 7.2	40	Clear	87	10
603686	S124, 9.2, 7.2, Halo	19	Frost	86	10
603688	S124, 9.2, 7.2, Halo	26	Frost	85	10
604920	S124, 9.2, 7.2, Halo	42	Frost	85	10

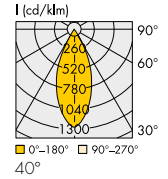
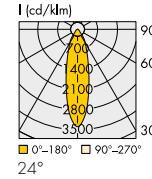
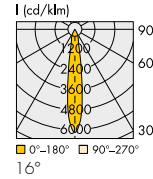

Optics Evolve 50 for LED Engines

Technical notes

For click-in fixation on holders Easy

Diameter: 50 mm

Material: PC

Operating temperature: -25 to 90 °C

Storage temperature: -40 to 90 °C

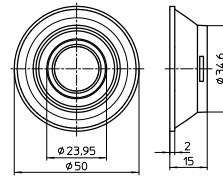

Ref. No.	For LED modules	Beam angle [°]	Cover	Optical efficiency (%)	Weight g
603672	S124, 9.2, 7.2, Halo*	14	—	87	15
603673	S124, 9.2, 7.2, Halo*	25	—	86	15
603674	S124, 9.2, 7.2, Halo*	34	—	89	15
604879	S124, 9.2, 7.2, Halo*	55	—	86	15

* In addition with mixing chamber

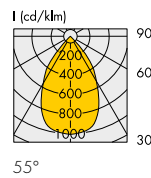
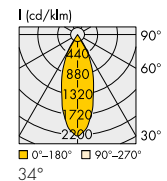
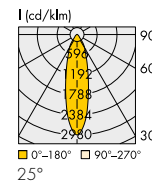
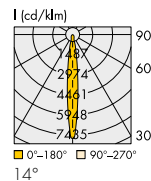

*Mixing Chamber for Halo

Material: PC

Fixation: click-in

Ref. No.: 604024

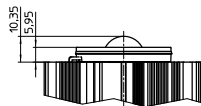

Flange Evolve

To reduce light leakage (optional)

Material: PBT, black

Ref. No.: 603681

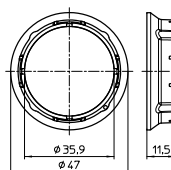

The values contained in this data sheet can change due to technical innovations. Any such changes will be made without separate notification.

Active LUGA S124 PLUS – up to 300 mA

Technical notes

Reflector: Ø 50 mm, heat sink material: aluminium
 Lumen maintenance: L90/B10; 50,000 hrs. 75 °C at t_p point
 Max. operating temperature at t_c point: 90 °C
 Temperature depends on installation situation and has to be checked by the luminaire manufacturer.
 Colour accuracy initially: 2 SDCM
 Plastic clear cover to protect reflector (opaque cover on request)
 Leads: Cu tinned, stranded conductors 0.5 mm², length: 200 mm, stripped lead ends (with plug on request)
 With integrated cord grip
 Packaging unit: 45 pcs.

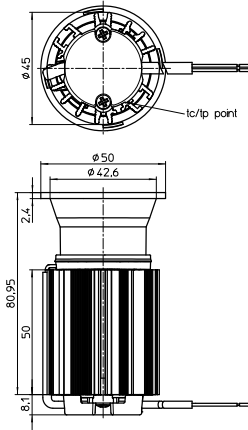

Electrical characteristics

Type	250 mA		300 mA	
	P _{el} [W]	V _f [V]	P _{el} [W]	V _f [V]
S124	8.3	33.4	10.2	33.8

Voltage and power tolerance: ± 10%

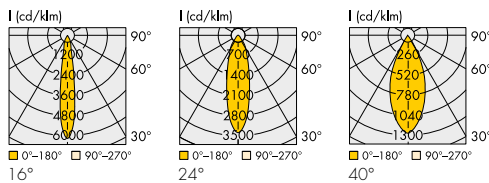

Type	Ref. No.	Colour	Correlated colour temp. K	Typ. luminous flux and efficiency at						Light intensity at max. current Candela	Beam angle °	CRI R _a	Energy efficiency at max. current
				250 mA		300 mA		350 mA					
				lm	lm/W	lm	lm/W	lm	lm/W				
Warm white – 2700 K													
Active S124W PLUS 27K	569098	warm white	2700	1060	128	1245	122	—	—	7500	16	82	A++
Active S124W PLUS 27K	569099	warm white	2700	1045	126	1230	121	—	—	4250	24	82	A++
Active S124W PLUS 27K	569100	warm white	2700	1060	128	1245	122	—	—	1570	40	82	A++
Warm white – 3000 K													
Active S124W PLUS 30K	569101	warm white	3000	915	110	1075	105	—	—	6350	16	95	A+
Active S124W PLUS 30K	569102	warm white	3000	905	109	1065	104	—	—	3650	24	95	A+
Active S124W PLUS 30K	569103	warm white	3000	915	110	1075	105	—	—	1330	40	95	A+
Neutral white – 4000 K													
Active S124W PLUS 40K	569104	neutral white	4000	1000	120	1175	115	—	—	6950	16	95	A++
Active S124W PLUS 40K	569105	neutral white	4000	990	119	1160	114	—	—	3950	24	95	A++
Active S124W PLUS 40K	569106	neutral white	4000	1000	120	1175	115	—	—	1450	40	95	A++

Production tolerance of luminous flux and efficiency: ± 10%

The values contained in this data sheet can change due to technical innovations. Any such changes will be made without separate notification.

Active LUGA S124 PLUS – up to 350 mA

Technical notes

Reflector: Ø 50 mm, heat sink material: aluminium
 Lumen maintenance: L90/B10; 50,000 hrs. 75 °C at t_p point
 Max. operating temperature at t_c point: 90 °C
 Temperature depends on installation situation and has to be checked by the luminaire manufacturer.
 Colour accuracy initially: 2 SDCM
 Plastic clear cover to protect reflector (opaque cover on request)
 Leads: Cu tinned, stranded conductors 0.5 mm², length: 200 mm, stripped lead ends (with plug on request)
 With integrated cord grip
 Packaging unit: 24 pcs.

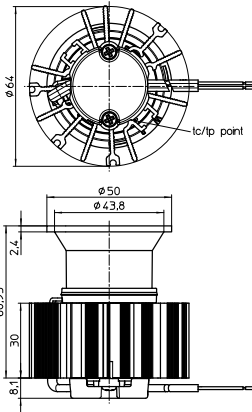

Electrical characteristics

Type	250 mA		300 mA		350 mA	
	P_{el} (W)	V_f (V)	P_{el} (W)	V_f (V)	P_{el} (W)	V_f (V)
S124	8.3	33.4	10.2	33.8	12.0	34.3

Voltage and power tolerance: ± 10%

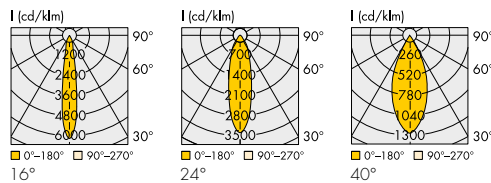

Type	Ref. No.	Colour	Correlated colour temp. K	Typ. luminous flux and efficiency at						Light intensity at max. current Candela	Beam angle °	CRI R_a	Energy efficiency at max. current
				250 mA		300 mA		350 mA					
				lm	lm/W	lm	lm/W	lm	lm/W				
Warm white – 2700 K													
Active S124W PLUS 27K	569107	warm white	2700	1060	128	1245	122	1430	119	8500	16	82	A++
Active S124W PLUS 27K	569108	warm white	2700	1045	126	1230	121	1410	118	4800	24	82	A++
Active S124W PLUS 27K	569109	warm white	2700	1060	128	1245	122	1430	119	1760	40	82	A++
Warm white – 3000 K													
Active S124W PLUS 30K	569110	warm white	3000	915	110	1075	105	1230	103	7320	16	95	A+
Active S124W PLUS 30K	569111	warm white	3000	905	109	1065	104	1220	102	4150	24	95	A+
Active S124W PLUS 30K	569112	warm white	3000	915	110	1075	105	1230	103	1520	40	95	A+
Neutral white – 4000 K													
Active S124W PLUS 40K	569113	neutral white	4000	1000	120	1175	115	1345	112	8000	16	95	A+
Active S124W PLUS 40K	569114	neutral white	4000	990	119	1160	114	1330	111	4550	24	95	A+
Active S124W PLUS 40K	569115	neutral white	4000	1000	120	1175	115	1345	112	1660	40	95	A+

Production tolerance of luminous flux and efficiency: ± 10%

The values contained in this data sheet can change due to technical innovations. Any such changes will be made without separate notification.

Active 9.2 PLUS

Technical notes

Reflector: Ø 50 mm, heat sink material: aluminium
 Lumen maintenance: L90/B20; 50,000 hrs. 75 °C at t_p point
 Max. operating temperature at t_c point: 90 °C
 Temperature depends on installation situation and has to be checked by the luminaire manufacturer.
 Colour accuracy initially: 3 SDCM
 Plastic clear cover to protect reflector (opaque cover on request)
 Leads: Cu tinned, stranded conductors 0.5 mm², length: 200 mm, stripped lead ends (with plug on request)
 With integrated cord grip
 Packaging unit: 45 pcs.

Electrical characteristics

Type	350 mA		500 mA	
	P_{el} [W]	V_f [V]	P_{el} [W]	V_f [V]
9.2	6.1	17.3	8.9	17.85

Voltage and power tolerance: ± 10%

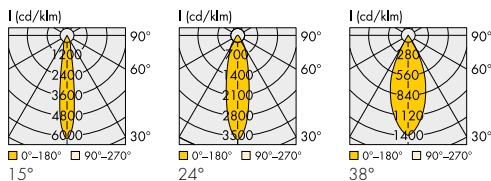
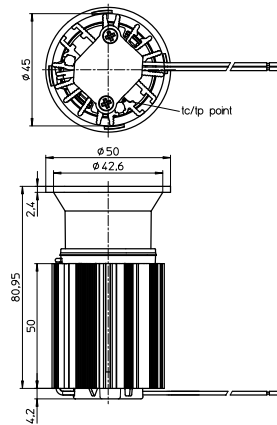

Type	Ref. No.	Colour	Correlated colour temp. K	Typ. luminous flux and efficiency at				Light intensity at max. current Candela	Beam angle °	CRI R _a	Energy efficiency at max. current
				350 mA lm	350 mA lm/W	500 mA lm	500 mA lm/W				
Warm white – 2700 K											
Active 9.2 PLUS 27K	567155	warm white	2700	680	111	950	107	5800	15	80	A+
Active 9.2 PLUS 27K	567156	warm white	2700	675	111	935	105	3410	24	80	A+
Active 9.2 PLUS 27K	569514	warm white	2700	680	111	950	107	1340	38	80	A+
Warm white – 3000 K											
Active 9.2 PLUS 30K	567158	warm white	3000	710	116	985	111	6050	15	80	A++
Active 9.2 PLUS 30K	567159	warm white	3000	705	116	975	110	3550	24	80	A++
Active 9.2 PLUS 30K	569515	warm white	3000	710	116	985	111	1380	38	80	A++
Neutral white – 4000 K											
Active 9.2 PLUS 40K	567160	neutral white	4000	740	121	1025	115	6300	15	80	A++
Active 9.2 PLUS 40K	567161	neutral white	4000	730	120	1015	114	3700	24	80	A++
Active 9.2 PLUS 40K	569591	neutral white	4000	740	121	1025	115	1430	38	80	A++

Production tolerance of luminous flux and efficiency: ± 10%

The values contained in this data sheet can change due to technical innovations. Any such changes will be made without separate notification.

Active 7.2 PLUS

Technical notes

Reflector: Ø 50 mm, heat sink material: aluminium
 Lumen maintenance: L90/B20; 50,000 hrs. 75 °C at t_p point
 Max. operating temperature at t_c point: 90 °C
 Temperature depends on installation situation and has to be checked by the luminaire manufacturer.
 Colour accuracy initially: 3 SDCM
 Plastic clear cover to protect reflector (opaque cover on request)
 Leads: Cu tinned, stranded conductors 0.5 mm², length: 200 mm, stripped lead ends (with plug on request)
 With integrated cord grip
 Packaging unit: 45 pcs.

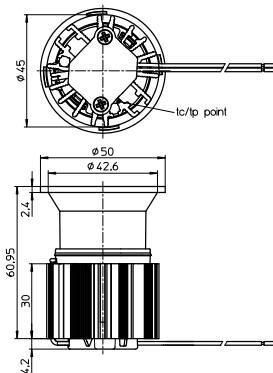

Electrical characteristics

Type	350 mA
	P _{el} [W] V _f [V]
7.2	6.1 17.3

Voltage and power tolerance: ± 10%

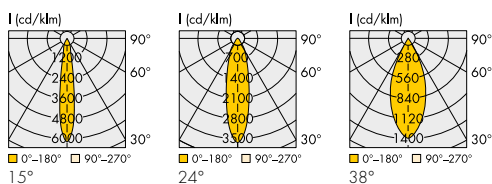

Type	Ref. No.	Colour	Correlated colour temp. K	Typ. luminous flux and efficiency at				Light intensity at max. current Candela	Beam angle °	CRI R _a	Energy efficiency at max. current
				350 mA lm	350 mA lm/W	500 mA lm	500 mA lm/W				
Warm white – 2700 K											
Active 7.2 PLUS 27K	567147	warm white	2700	680	111	—	—	4270	15	80	A++
Active 7.2 PLUS 27K	567148	warm white	2700	675	111	—	—	2495	24	80	A++
Active 7.2 PLUS 27K	569511	warm white	2700	680	111	—	—	980	38	80	A++
Warm white – 3000 K											
Active 7.2 PLUS 30K	567150	warm white	3000	710	116	—	—	4450	15	80	A++
Active 7.2 PLUS 30K	567151	warm white	3000	705	116	—	—	2600	24	80	A++
Active 7.2 PLUS 30K	569512	warm white	3000	710	116	—	—	1020	38	80	A++
Neutral white – 4000 K											
Active 7.2 PLUS 40K	567152	neutral white	4000	740	121	—	—	4620	15	80	A++
Active 7.2 PLUS 40K	567153	neutral white	4000	730	120	—	—	2700	24	80	A++
Active 7.2 PLUS 40K	569513	neutral white	4000	740	121	—	—	1050	38	80	A++

Production tolerance of luminous flux and efficiency: ± 10%

The values contained in this data sheet can change due to technical innovations. Any such changes will be made without separate notification.

Active Halo PLUS

Dim2Warm

Technical notes

Reflector: Ø 50 mm
 Heat sink material: aluminium
 Lumen maintenance: L70/B10; 30,000 hrs. 65 °C (350 mA)
 at t_p point
 Max. operating temperature at t_c point: 75 °C at 350 mA
 Temperature depends on installation situation and has to be checked by the luminaire manufacturer.
 Colour accuracy initially: 3 SDCM
 Plastic frost cover to protect reflector
 Leads: Cu tinned, stranded conductors 0.5 mm²,
 length: 200 mm, with plug
 With integrated cord grip
 Weight: 150 g
 Packaging unit: 24 pcs.

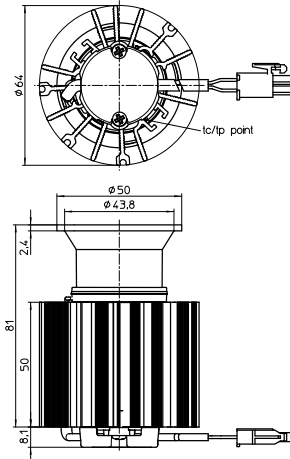

Electrical characteristics

Type	50 mA		350 mA	
	P_{el} [W]	V_f [V]	P_{el} [W]	V_f [V]
Active HALO	1.6	31.4	12.9	37

Voltage and power tolerance: $\pm 10\%$

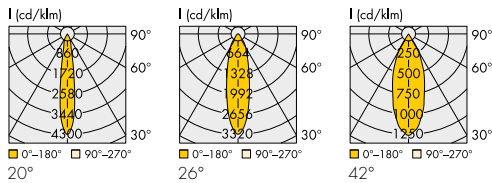

Type	Ref. No.	Colour	Correlated colour temp. K	Typ. luminous flux and colour temperature at		Light intensity at max. current Candela	Beam angle °	CRI R_a	Energy efficiency at max. current
				50 mA lm	350 mA lm				

ActiveLine HALO – Warm white

Active HALO PLUS	on request	warm white	3000 → 2000	115	2000	1040	3000	3350	22	90	A+
Active HALO PLUS	on request	warm white	3000 → 2000	110	2000	1030	3000	2530	28	90	A+
Active HALO PLUS	on request	warm white	3000 → 2000	110	2000	1030	3000	1600	44	90	A+

Production tolerance of luminous flux: $\pm 10\%$

The values contained in this data sheet can change due to technical innovations. Any such changes will be made without separate notification.

LED Drivers

You will find more information about our LED drivers on our website: www.vossloh-schwabe.com

Capacity range (W)		Output current DC	Output voltage DC	Mains voltage (V)	Ref. No.	Version	Current setting	Dimming	Max. service life	at t _c	Dimensions (LxWxH)	For type		
min.	max.	mA	V	50–60 Hz					hrs.	°C	mm	7.2	9.2	S124W
250 mA														
5	10	250	20–40	220–240	186708	EasyLine	—	—	50,000	65	115x45x25	—	—	x
5	10	250	20–40	220–240	186710	EasyLine	—	Phase-cut	50,000	65	115x45x25	—	—	x
6.25	10.5	250	25–42	220–240	186843	ComfortLine	DIP switch	—	50,000	70	97x43x30	—	—	x
6.25	10.75	250	25–43	220–240	186650	ComfortLine	LEDSet	—	100,000	70	97x43x30	—	—	x
6.25	10.75	250	25–43	220–240	186664	ComfortLine	LEDSet	—	100,000	70	97x43x30	—	—	x
6.25	10.75	250	25–43	220–240	186831	ComfortLine	Terminals	—	50,000	70	97x43x30	—	—	x
6.25	13	250	25–52	220–240	186913	ComfortLine	LEDSet	—	60,000	80	103.6x67.4x31	—	—	x
6.65	9.5	250	26.5–38	220–240	186922	EasyLine	—	—	50,000	65	97x43x25	—	—	x
6.75	12	250	27–48	220–240	186449	EasyLine	—	Phase-cut	50,000	60	122.8x45x19	—	—	x
7.25	10	250	29–40	220–240	186908	EasyLine	—	Phase-cut	50,000	70	85x50x19	—	—	x
300 mA														
3	16.2	300	10–54	220–240	186762	PrimeLine	DIP switch	DALI	100,000	75	97.2x43.2x30.1	x	x	x
3	16.2	300	10–54	220–240	186763	PrimeLine	DIP switch	DALI	100,000	75	146.5x43.2x30.1	x	x	x
6	12	300	20–40	220–240	186709	EasyLine	—	—	50,000	65	115x45x25	—	—	x
6	12	300	20–40	220–240	186711	EasyLine	—	Phase-cut	50,000	65	115x45x25	—	—	x
7.5	12.9	300	25–43	220–240	186650	ComfortLine	LEDSet	—	100,000	70	97x43x30	—	—	x
7.5	12.9	300	25–43	220–240	186664	ComfortLine	LEDSet	—	100,000	70	97x43x30	—	—	x
7.5	12.9	300	25–43	220–240	186831	ComfortLine	Terminals	—	50,000	70	97x43x30	—	—	x
7.5	15.6	300	25–52	220–240	186913	ComfortLine	LEDSet	—	60,000	80	103.6x67.4x31	—	—	x
8.1	11.4	300	27–38	220–240	186923	EasyLine	—	—	50,000	65	97x43x25	—	—	x
350 mA														
0.7	11.2	350	2–32	220–240	186679	ComfortLine	—	—	50,000	70	128x37x28	x	x	—
1.05	8.75	350	3–25	220–240	186519	ComfortLine	—	—	50,000	80	65x30.7x21.5	x	x	—
2.95	12.6	350	8.4–36	220–240	186341	EasyLine	—	—	50,000	65	122.8x45x19	x	x	x
3.5	18.9	350	10–54	220–240	186762	PrimeLine	DIP switch	DALI	100,000	75	97.2x43.2x30.1	x	x	x
3.5	18.9	350	10–54	220–240	186763	PrimeLine	DIP switch	DALI	100,000	75	146.5x43.2x30.1	x	x	x
5.25	16.1	350	15–46	220–240	186719	EasyLine	—	—	50,000	70	97.1x42x6x30.3	x	x	x
5.25	16.1	350	15–46	220–240	186720	EasyLine	—	—	50,000	70	146.5x43.7x30	x	x	x
6.3	19.95	350	18–57	220–240	186431	EasyLine	—	—	50,000	65	122.8x45x19	—	—	x
7	19.95	350	20–57	220–240	186581	ComfortLine	Terminals	1–10 V	50,000	80	103.6x67.4x31	—	—	x
8.05	16.1	350	23–46	100–240	186917	EasyLine	—	—	30,000	75	122.8x45x19	—	—	x
8.75	14.7	350	25–42	220–240	186843	ComfortLine	DIP switch	—	50,000	70	97x43x30	—	—	x
8.75	15.05	350	25–43	220–240	186650	ComfortLine	LEDSet	—	100,000	70	97x43x30	—	—	x
8.75	15.05	350	25–43	220–240	186664	ComfortLine	LEDSet	—	100,000	70	97x43x30	—	—	x
8.75	15.05	350	25–43	220–240	186831	ComfortLine	Terminals	—	50,000	70	97x43x30	—	—	x
8.75	18.2	350	25–52	220–240	186913	ComfortLine	LEDSet	—	60,000	80	103.6x67.4x31	—	—	x
9.75	13.85	350	27.8–38.8	220–240	186924	EasyLine	—	—	50,000	65	97x43x25	—	—	x
10.15	14	350	29–40	220–240	186909	EasyLine	—	Phase-cut	50,000	70	85x50x19	—	—	x
10.5	15.5	350	30–43	220–240	186591	EasyLine	—	—	30,000	65	115x45x25	—	—	x
400 mA														
4	21.6	400	10–54	220–240	186762	PrimeLine	DIP switch	DALI	100,000	75	97.2x43.2x30.1	—	x	on request
4	21.6	400	10–54	220–240	186763	PrimeLine	DIP switch	DALI	100,000	75	146.5x43.2x30.1	—	x	on request
10	17.2	400	25–43	220–240	186650	ComfortLine	LEDSet	—	100,000	70	97x43x30	—	—	on request
10	17.2	400	25–43	220–240	186664	ComfortLine	LEDSet	—	100,000	70	97x43x30	—	—	on request
10	17.2	400	25–43	220–240	186846	ComfortLine	Terminals	—	100,000	70	97x43x30	—	—	on request
10	20.8	400	25–52	220–240	186913	ComfortLine	LEDSet	—	60,000	80	103.6x67.4x31	—	—	on request
12	16.2	400	30–40.6	220–240	186935	EasyLine	—	—	50,000	65	97x43x25	—	—	on request
500 mA														
1	16	500	2–32	220–240	186680	ComfortLine	—	—	50,000	70	128x37x28	—	x	—
2	12	500	4–24	220–240	186508	EasyLine	—	—	50,000	60	122.8x45x19	—	x	—
4	15	500	8–30	220–240	186349	EasyLine	—	—	50,000	65	122.8x45x19	—	x	—
5	27	500	10–54	220–240	186762	PrimeLine	DIP switch	DALI	100,000	75	97.2x43.2x30.1	—	x	—
5	27	500	10–54	220–240	186763	PrimeLine	DIP switch	DALI	100,000	75	146.5x43.2x30.1	—	x	—
6.5	10	500	13–20	220–240	186448	EasyLine	—	Phase-cut	50,000	60	122.8x45x19	—	x	—
7.5	23	500	15–46	220–240	186721	EasyLine	—	—	50,000	70	97.1x42x6x30.3	—	x	—
7.5	23	500	15–46	220–240	186722	EasyLine	—	—	50,000	70	146.5x43.7x30	—	x	—

Please ensure you choose the correct LED driver for the module in question and that the respective output parameters (current, voltage, wattage) are correct.

The values contained in this data sheet can change due to technical innovations. Any such changes will be made without separate notification.

LEDSpots Active PLUS

General information

Performance acc. to IEC 62717: $t_p = 90\text{ }^\circ\text{C}$ (S124) or $t_p = 85\text{ }^\circ\text{C}$ (7.2/9.2); 100,000 hrs.

Packaging unit

Type	Packaging unit pcs.	Box dimensions (LxWxH) mm	Weight single (g)	Gross weight packaging unit (g)
Engine S124 - 300mA	45	600x400x80	100	4900
Engine S124 - 350mA	28	600x400x90	110	3480
Engine 7.2	90	600x400x80	80	7600
Engine 9.2	45	600x400x110	100	4900
Engine HALO	28	600x400x90	140	4320
Reflector PLUS	30	370x290x35	10	700
Lenses Evolve 50	30	370x290x35	15	850
Active S124 PLUS - 300mA	45	600x400x105	110	5350
Active S124 PLUS - 350mA	24	600x400x90	120	3280
Active 7.2 PLUS	45	600x400x80	90	4450
Active 9.2 PLUS	45	600x400x105	110	5350
Active PLUS HALO	24	600x400x105	150	4000

Product guarantee

- 5 years
- The conditions for the Product Guarantee of the Vossloh-Schwabe Group shall apply as published on our homepage (www.vossloh-schwabe.com). We will be happy to send you these conditions upon request.

General safety and installation instructions

- VS product may only be installed and commissioned by authorised and fully qualified staff.
- These instructions must be carefully read before installing and commissioning the system, as this is the only way to ensure safe and correct handling.
- An external constant-current driver is required.
- Before any work is carried out on the equipment, it must be disconnected from the mains.
- All valid safety and accident-prevention regulations must be observed.
- The products should never be inexpertly opened. Repairs may only be undertaken by the manufacturer.

Built-in

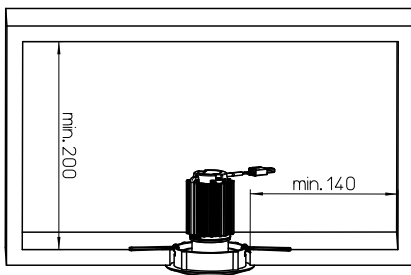

Correct position

OK

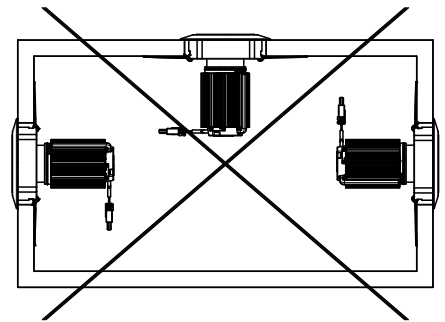
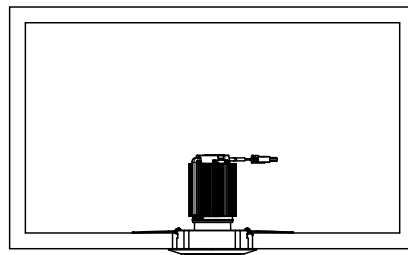

The values contained in this data sheet can change due to technical innovations. Any such changes will be made without separate notification.